

NOTICE:

This device complies with Part 15 of the FCC Rules. Operation shall be subject to the following two conditions:

- (1) This device may not cause harmful interface, and
- (2) This device must accept any interface received, including interface that may cause undesirable operation.

This equipment has been tested and complied with the limits for a Class A digital device, pursuant to Part 15 of the FCC Rules. These limits are designed to provide a reasonable protection against harmful interference when the equipment is operated under a commercial environment. This equipment generates, uses, and can radiate radio frequency energy and, if not installed and used in accordance with the instruction manual, may cause harmful interference to radio communications. Operation of this equipment in a residential area is likely to cause harmful interference in which case the user will be required to correct the interference at his own expenses.

Note: *All brands and trademarks shall belong to their respective owner.*

Note: *Specification is subject to changes without notice.*

Using the ArgoxScan

8000/8120/8150/8250/8310/8312

The ArgoxScan can automatically scan barcode at a distance.

Simply aim and pull the trigger. Code scanning is performed along the center of the light bar emitted from the reading window. This bar must cover the entire code.

Successful scanning shall be obtained by tilting the scanner with respect to the barcode to avoid direct reflections that impair the reading performance, especially for 2D barcode.

Recommended Steps

When the required settings have been configured, all settings are stored in non-volatile memory of scanner after reading EXIT Label. Recommended steps are as follows.

- 1) Set right host interface for your scanner.
(The scanner is in factory default shown as bold label)
- 2) Set interface to optimize protocol of scanner with your host in interface section.
- 3) Set system control of scanner, such as specific adjustments double confirm, power saving, indicator and scanning mode which you prefer usage in system control section.
- 4) Set code options of scanner for your usage in code option section. You must make sure to enable the symbology first, then Min./Max. code length, code ID checksum and truncate digits are also converted.
- 5) Set string format of the scanner, such as preamble, postamble Prefix, suffix, code ID and code name transmission for your application in string format section.

Note: *If still not work properly. Please contact your dealer for further information.*

Introduction

Installation- Keyboard Wedge

- 1) First of all, you must switch off power for the terminal/computer.
- 2) Disconnect the keyboard cable from the back of the terminal/computer.
- 3) Connect the appropriate interface cable to the scanner and to the terminal/computer.
- 4) Turn the terminal/computer power on.

RS-232

- 1) Disconnect power to the terminal/computer.
- 2) Connect the appropriate interface cable and external power supply (DC adapter) to the scanner.
- 3) Plug the serial connector into the serial port on the back of your computer/terminal. Tighten the two screws to secure the connector to the port.
- 4) Plug the power pack into power source.
- 5) Once the scanner has been fully connected, turn the terminal/computer power back on.

USB (Simulate with keyboard wedge)

- 1) Connect the USB cable between scanner and PC.
- 2) Windows will automatically detect the USB device.

Note: *If any of the above operation is incorrect, turn off the power immediately and check any improper connections. Go through all above steps again.*

Note: *If you need more programming parameters to setup your ArgoScan scanner, please go to www.argox.com and download the completed user's manual.*





Programming the ArgoScan 8110/8120/8150/8250/8310/8312

To program the 8110/8120/8150/8250/8310/8312, you must scan a series of programming barcode in the correct order. Fold out the back cover of this manual. You will see a table of alphanumeric barcodes, which are used to program the various options presented.

To program each option, you must:



1. Scan the **Program** barcode on the parameter setting part.
2. Enter the option mode by scanning the **Option Bar Code** (also on the Parameter setting part).
3. To the right of the option barcode, the necessary alphanumeric inputs are listed. Scan these alphanumeric entries from the **back fold out** page. To confirm above steps, you must scan the **Finish** barcode on the back fold out page.
4. Once you have finished programming. Scan the **Exit** barcode, listed on the lower right hand corner of each parameter setting part.

Interface Selection

Keyboard Wedge	
RS-233	
Wand Emulation (8110/8150/8250)	
USB	
Keyboard /RS232/USB Auto detection	

Note: * -Default





Keyboard Layout

USA *	
Belgium	
Danish	

Keyboard Layout - Continued

France	
Germany	
Italian	
Portuguese	
Spanish	
Swedish	
Switzerland	
UK	
Latin American	
Japanese	

RS-232 Flow Control

None *	
RTS/CTS	
Xon/Xoff	
ACK/NAK	



RS-232 Baud Rate Setting

300 BPS	
600 BPS	
1200 BPS	
2400 BPS	
4800 BPS	
9600 BPS *	



RS-232 Baud Rate Setting (Continued)

19200 BPS	
38400 BPS	

RS-232 Parity Setting

None *	
Odd	
Even	

RS-232 Data Bit Setting

8 bits *	
7 bits	

Pin Assignments

AS Series 8-pin RJ-45 Connector

Pin	RS-232	Keyboard
1	VCC (+5V)	VCC (+5V)
2	TXD	NC
3	NC	CLK / PC
4	NA	DATA / PC
5	CTS	DATA / KB
6	RXD	NC
7	RTS	CLK / KB
8	GND	GND

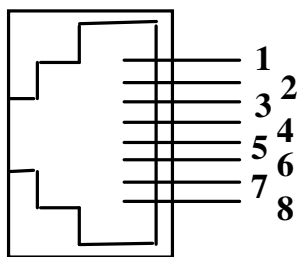

8-pin

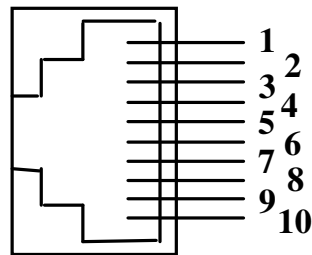

10-pin

AS Series 10-pin RJ-45 Connector

Pin	RS-232	Keyboard
1	I/F	I/F
2	VCC (+5V)	VCC (+5V)
3	TXD	NC
4	NC	CLK / PC
5	GND	DATA / PC
6	CTS	DATA / KB
7	RXD	NC
8	RTS	CLK / KB
9	GND	GND
10	NC	GND

Keyboard Wedge Combo Connector (To Host Side):

Pin	Mini-DIN 6P Male	DIN 5P Female
1	DATA / PC	DATA / KB
2	NC	NC
3	GND	GND
4	VCC (+5V)	VCC (+5V)
5	CLK / PC	CLK / KB
6	NC	NC

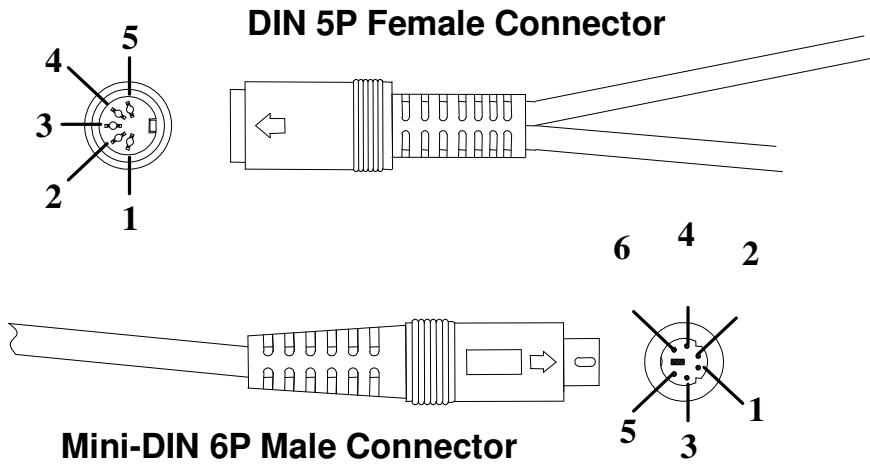

RS-232 DB-9F Connector (To Host Side):

Pin	Definition
1	NC
2	TXD
3	RXD
4	NC
5	GND
6	NC
7	CTS
8	RTS
9	VCC (+5V)

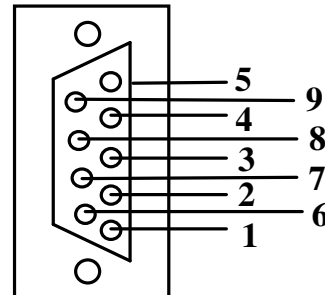

Keyboard Wedge PS/2 Connector (To Host Side):

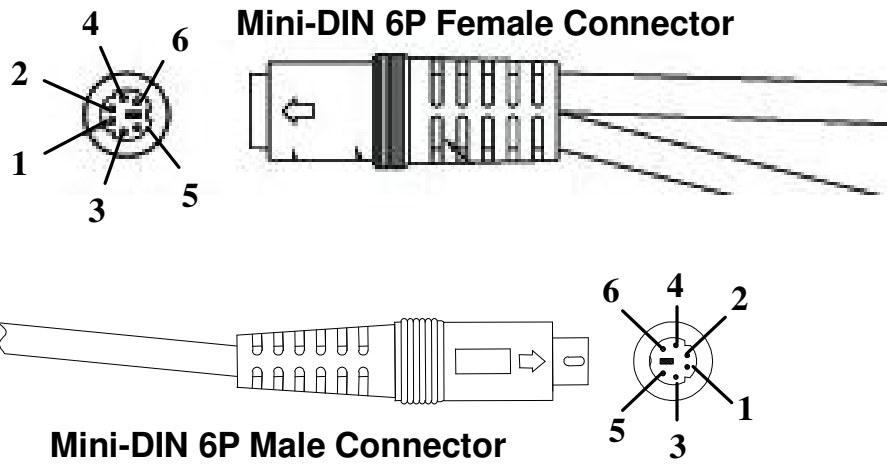

Pin	Mini-DIN 6P Male	Mini-DIN 6P Female
1	DATA / PC	DATA / KB
2	NC	NC
3	GND	GND
4	VCC (+5V)	VCC (+5V)
5	CLK / PC	CLK / KB
6	NC	NC





Scan Mode

Good-read off	
Momentary *	
Alternate	
Timeout off	
Continue	
Test only	













Stand Mode Enable

Stand mode	 + 
------------	---





Suffix Characters Setting (Keyboard Wedge & USB)

Enter *	
Tab	
None	

Enable Barcode

Industrial 2 of 5	
Matrix 2 of 5 Eur	
Standard 2 of 5	
Codabar	
Code 93	
Code 11	
MSI/Plessey	
UK/Plessey	
Telepen	
China Post	
Italian Pharmacode (Code 32)	
Code-16K (for 8250/8312)	

Enable Barcode - Continued









EAN UCC Composite (for 8312)	
RSS-14	
RSS-Limited	
RSS-Expanded	
Micro-PDF (for 8312)	

Note: All other barcodes not listed in the table are set to be enabled in default.

UPCA Supplement digits (for 8120/8150/8250)

None *	
2 digits	
5 digits	
UCC/EAN 128	
Auto detection	









UPCA Supplement digits (for 8310/8312)

None *	
2 digits	
5 digits	
2, 5 digits	
UCC/EAN 128	
2, UCC/EAN 128	
5, UCC/EAN 128	
All	



UPCE Supplement digits (for 8120/8150/8250)

None *	
2 digits	
5 digits	
UCC/EAN 128	
Auto detection	





UPCE Supplement digits (for 8310/8312)

None *	
2 digits	
5 digits	
2, 5 digits	
UCC/EAN 128	
2, UCC/EAN 128	
5, UCC/EAN 128	
All	



UPCA Truncation/Expansion

None *	
Truncate leading zero	
Expand to EAN-13	





UPCE Truncation/Expansion

None *	
Truncate leading zero	
Expand to EAN-13	
Expand to UPCA	

UPCE Expansion

None *	
Truncate leading zero	

EAN-13 Supplement digits (for 8120/8150/8250)

None *	
2 digits	
5 digits	
UCC/EAN 128	
Auto detection	

EAN-13 Supplement digits (for 8310/8312)

None *	
2 digits	
5 digits	
2, 5 digits	
UCC/EAN 128	
2, UCC/EAN 128	
5, UCC/EAN 128	
All	

EAN-8 Supplement digits (for 8120/8150/8250)

None *	
2 digits	
5 digits	
UCC/EAN 128	
Auto detection	

EAN-8 Supplement digits (for 8310/8312)

None *	
2 digits	
5 digits	
2, 5 digits	
UCC/EAN 128	
2, UCC/EAN 128	
5, UCC/EAN 128	
All	





ISBN/ISSN Conversion

Disable *	
Enable	







EAN-8 Expansion

None *	
Truncate leading zero	

Code 39 Check-sum setting

Verification Disable *	
Verification Enable	
Transmit Disable *	
Transmit Enable	

Code 39 Format setting

Standard *	
Full ASCII	
Append Disable *	
Append Enable	
Start/End Tx Disable *	
Start/End Tx Enable	

Test Chart (Bar code samples marked with symbol “*” are enabled initially.)

CODABAR-PARA (8110 *)



a154987a

CODE-11 PARA

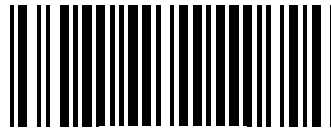

654215

CODE-128 PARA *

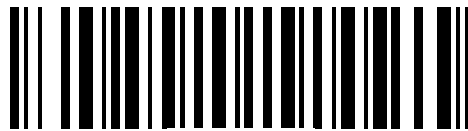

258963

CODE-39 PARA *

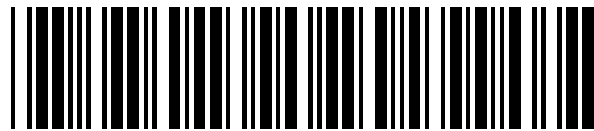

741258

CODE-93 PARA

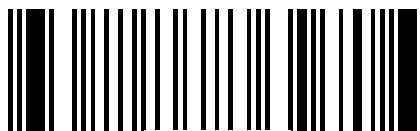

951263

EAN-13 PARA *

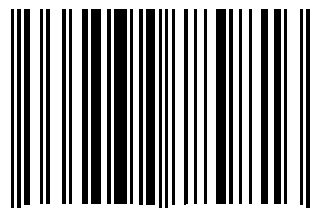

7 534539 789813

PDF-417 (8250/8312 *)



STANDRAD-25 PARA

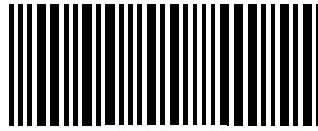

65978

CODE-16K

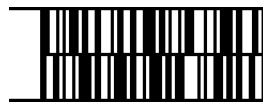

87549

EAN-8 PARA *



9456 2156

INDUSTRIAL-25 PARA

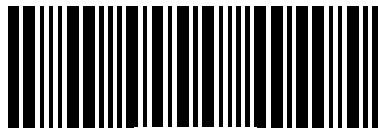

04976

UPCE PARA *



0 095601 1

INTERLEAVED-25 PARA *

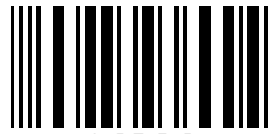

46820

MATRIX 25 PARA

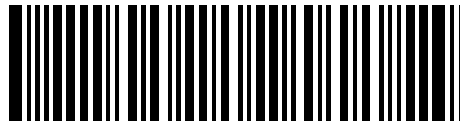

4563535663

MSI/PLESSEY PARA

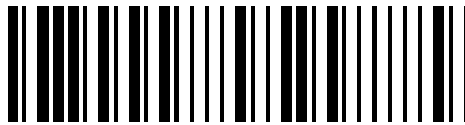

754268

UPCA PARA *

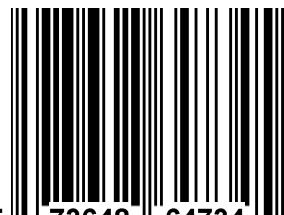

5 73648 64734 5

UK/PLESSEY PARA



64872

GS1 Databar



Micro-PDF (8312 *)

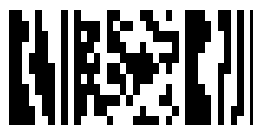

ASCII Code Table Note: For keyboard wedge only.

L \ H	0	1	0	1
0	Null		NUL	DLE
1	Up	F1	SOH	DC1
2	Down	F2	STX	DC2
3	Left	F3	ETX	DC3
4	Right	F4	EOT	DC4
5	PgUp	F5	ENQ	NAK
6	PgDn	F6	ACK	SYN
7		F7	BEL	ETB
8	Bs	F8	BS	CAN
9	Tab	F9	HT	EM
A		F10	LF	SUB
B	Home	Esc	VT	ESC
C	End	F11	FF	FS
D	Enter	F12	CR	GS
E	Insert	Ctrl+	SO	RS
F	Delete	Alt+	SI	US

L \ H	2	3	4	5	6	7
0	SP	0	@	P	`	p
1	!	1	A	Q	a	q
2	"	2	B	R	b	r
3	#	3	C	S	c	s
4	\$	4	D	T	d	t
5	%	5	E	U	e	u
6	&	6	F	V	f	v
7	'	7	G	W	g	w
8	(8	H	X	h	x
9)	9	I	Y	i	y
A	★	:	J	Z	j	z
B	+	;	K	[k	{
C	,	<	L	\	l	
D	-	=	M]	m	}
E	.	>	N	^	n	~
F	/	?	O	_	o	DEL

Parameter Setting List



\$%+PRO

Program



!BS

Barcode standard parameter setting list

If you wish to display the current configuration of your AS-8110/8120/8150/8250/8310/8312, scanner over the host terminal/computer, scan the Barcode standard parameter setting list bar code.



!BU

Unique parameter list

If you wish to display the unique parameter setting list, scan the unique parameter list bar code



!SY

System parameter setting list

If you wish to display the product information and revision number for your AS-8110/8120/8150/8250/8310/8312 scanner over the host terminal/computer, scan the System parameter setting list bar code.



!ST

String setting list

If you wish to display the string format list, scan the String setting list bar code.



%\$\$

Exit

Query present scanner firmware version



\$%+PRO

Program



!VR

Firmware version list

If you wish to display the firmware version, scan the “Firmware version list” barcode.



%\$\$

Exit

Reset scanner to factory default settings



\$%+PRO

Program



!IN

WARNING: Default value initialization

If you wish to return the AS-8110/8120/8150/8250/8310 to all the factory default settings, scan the Default value initialization bar code.



/0 **0**



/1 **1**



/2 **2**



/3 **3**



/4 **4**



/5 **5**



/6 **6**



/7 **7**



/8 **8**



/9 **9**



/A **A**



/B **B**



/C **C**



/D **D**



/E **E**



/F **F**



/%% **Finish**